

eNet universal radio transmitter 2-gang mini

Art. No. : FMUS2UP

Operating instructions**1 Safety instructions**

Electrical devices may only be mounted and connected by electrically skilled persons.

Serious injuries, fire or property damage possible. Please read and follow manual fully.

Danger of electric shock. Always disconnect before carrying out work on the device or load. In so doing, take all the circuit breakers into account, which support dangerous voltages to the device and or load.

Do not connect any motors in parallel with the transmitter. Device can be damaged.

The radio communication takes place via a non-exclusively available transmission path, and is therefore not suitable for safety-related applications, such as emergency stop and emergency call.

These instructions are an integral part of the product, and must remain with the end customer.

2 Device components

Figure 1: Front view

- (1) Operating mode switch
- (2) Button **Prog.**
- (3) Status LED
- (4) Signal lamp connection
- (5) Terminals
E1, E2: Inputs
L, N: Power supply

3 Function**Intended use**

- Transmitter for radio communication of switching, dimming, blind movement and scene commands

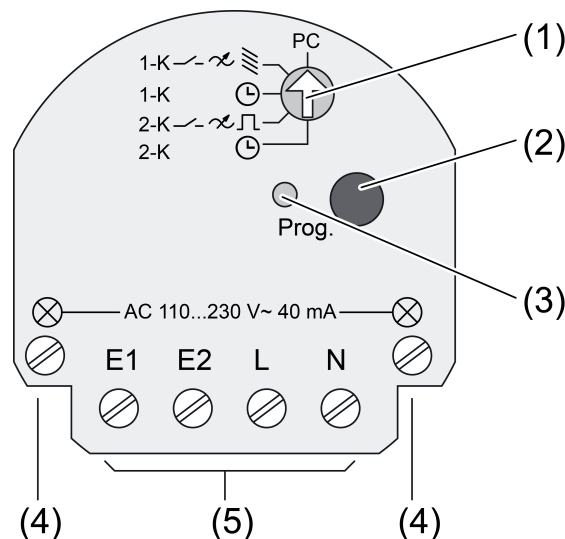
- Activation by push-button, switch, shutter push-button, shutter switch or other devices with push-button contact or switching contact
- Mounting in appliance box according to DIN 49073 with a suitable cover
- Mounting in surface-mounted housing or built-in housing (accessory) for false ceilings
- Operation with radio actuators from the eNet system

Product characteristics

- Detection of voltage levels and changes on the input
- Settable transmission behaviour
- Connection for signal lamp – e.g. for connection of push-buttons with separate signal contact
- Display of transmission status with status LED or signal lamp

Operating modes, settable with operating mode switch:

- 1-gang switching/dimming/venetian blind
- 1-gang automatic function
- 2-gang switching/dimming/push-button operation
- 2-gang automatic function

Can be set with eNet server:

- Fully encrypted radio transmission (AES-CCM) from eNet Server software version 2.0
- Scenes: All On, All Off, individual scenes
- 2-gang blind
- Operation locks
- Setup connections enabled/disabled
- Status for restraint
- Repeater function
- Update device software

4 Operation

- i** When operating with the eNet Server, operation and signalling could vary from what is described here.

One and two-button operation

The operation of functions or electrical consumers depends on the application and the connected components.

The operation of the usual switching function follows if switches are connected.

Two operating modes are used when push-buttons are connected:

- Single button operation - lighting:
Switching lighting on or off or dimming it brighter/darker takes place alternately when the appropriate button is pressed repeatedly.
- Two button operation - lighting:
Two buttons form a function pair. Pressing the left button switches or dims lighting on or brighter, pressing the right one switches it off or makes it darker.
- Single button operation - blind:
Upward or downward movement takes place alternately when the appropriate button is pressed repeatedly.
- Two button operation - blind:
Two buttons form a function pair. Pressing the left button moves a blind upwards, pressing the right one moves it downwards.

Status indication

- Status LED/signal lamp on: transmission active
 - Status LED/signal lamp flashes quickly for 5 seconds: transmission faulty
- i** Push-button with signal contact and signal lamp repeat the display of the internal status LED (3).

Operating light

- Switch: Short press on button.
- Dim: Long press on the button. The dimming process ends when the button is released.

Operating blind

- Move Venetian blind: Long press on button.
- Stop or adjust Venetian blind: Short press on button.
- ⓘ With two independent functions and push-button operation (operating mode 2-gang Venetian blind):
Change of direction for moving Venetian blind: Long press of button.
Change of direction for stationary Venetian blind: First, brief press of the button, then long press of the button.

Operating push-button actuator

- Press the button.
The load is switched on for the duration of the button-press.
- ⓘ The maximum actuation length is 60 seconds.

Recalling scenes

- Press button briefly.
Actuators switch to the saved scene value.

Changing scene

- Press button briefly.
Actuators switch to the saved scene value.
- Set new scene values.
- Press the button for longer than 4 seconds.
Actuators first switch to the saved scene value and save the new scene value after 4 seconds.

Save switch-on brightness

With dimmer actuators a brightness value can be saved to which the actuator switches after a short button press.

Only for two button operation.

- Set required switch-on brightness.
- Press both buttons simultaneously for longer than 4 seconds.
The light is briefly switched off and switched on again to the switch-on brightness. Switch-on brightness is saved.

5 Information for electrically skilled persons



DANGER!

**Electrical shock on contact with live parts in the installation environment.
Electrical shocks can be fatal.**

Before working on the device, disconnect the power supply and cover up live parts in the working environment.

5.1 Fitting and electrical connection

Connecting and fitting the device

Recommendation: Use deep appliance box.

To ensure good transmission quality, keep a sufficient distance from possible interference sources, e.g., metallic surfaces, microwave ovens, hi-fi and TV sets, ballasts or transformers.

- Select the operating mode (see Operating modes).
- Connect the radio transmitter according to the operating mode and the connection example.
- Insert the radio transmitter in the appliance box in such a way that the **Prog.** button and the status LED are visible.

eNet universal radio transmitter 2-gang mini

- If multiple circuit breakers supply dangerous voltages to the device or load, couple the miniature circuit breakers or label them with a warning, to ensure disconnection is guaranteed.
- ⓘ Do not connect the radio transmitter in parallel with a blind motor.
- Set the mode of operation (see chapter 5.2. Commissioning).
- Connect with actuators (see chapter 5.2. Commissioning).
- ⓘ In installation positions that are not easily accessible, turn the operating mode switch to position **PC** after commissioning and performing a function test. Subsequent changes to the device settings can thus be carried out with the aid of the eNet Server without involving excessive installation work.
- Mount the cover.

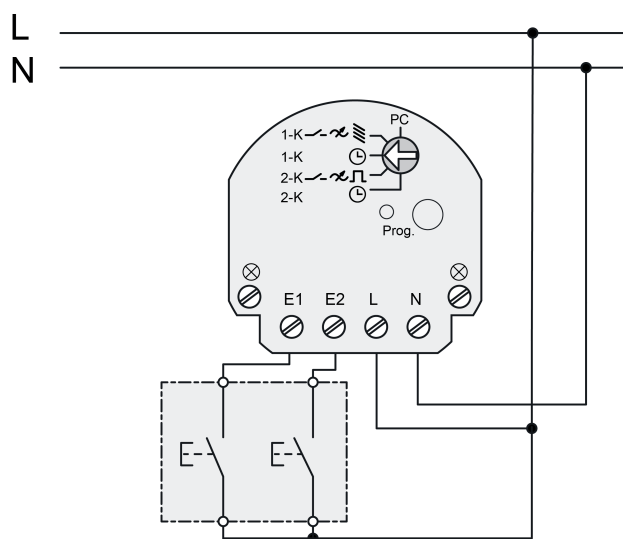

Figure 2: Connection example with series push-button

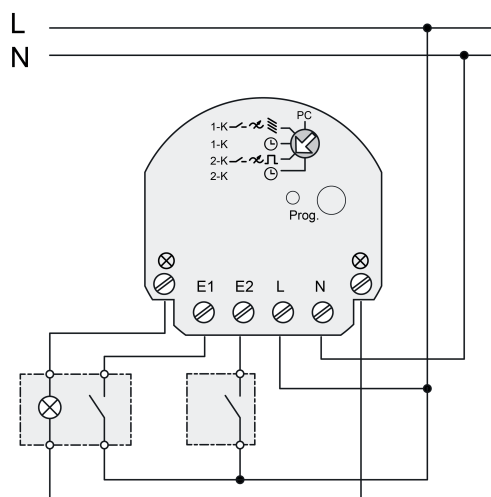

Figure 3: Connection example with push-button and signal lamp

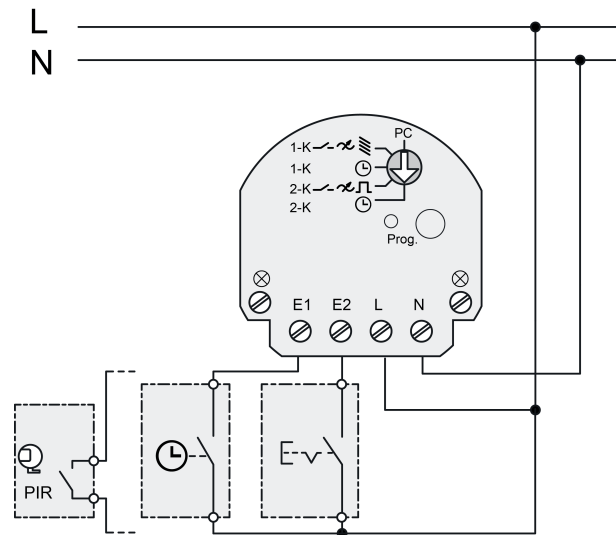

Figure 4: Connection example with switch, timer or motion detector

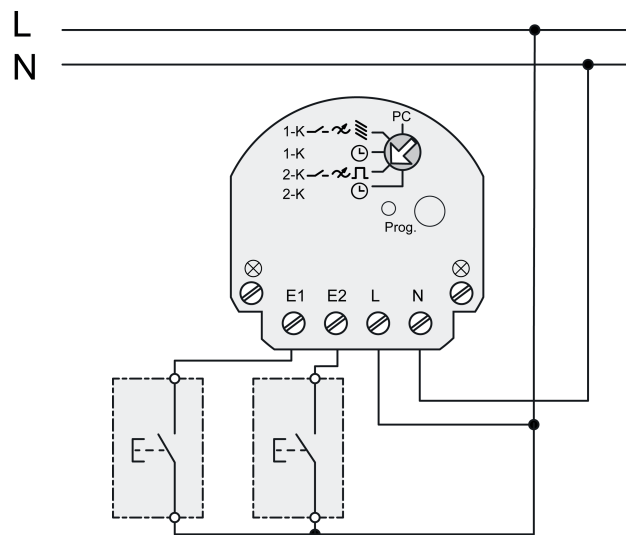

Figure 5: Connection example with 2 push-buttons

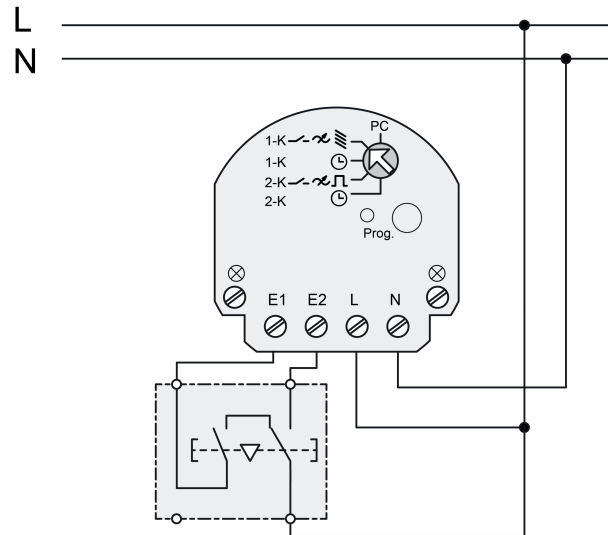

Figure 6: Connection example with venetian blind push-button

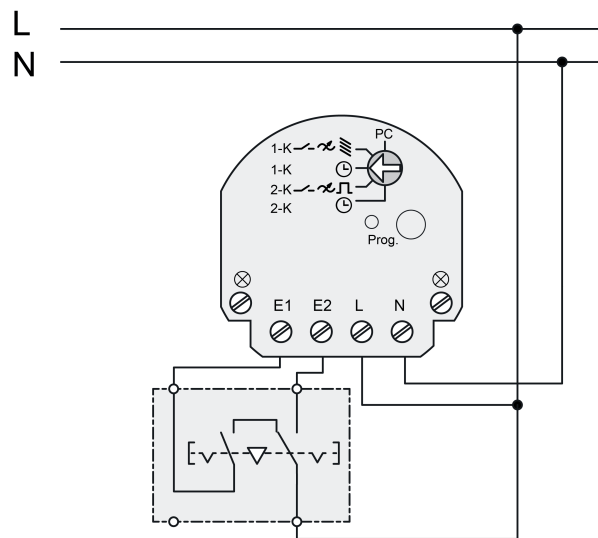

Figure 7: Connection example with venetian blind switch

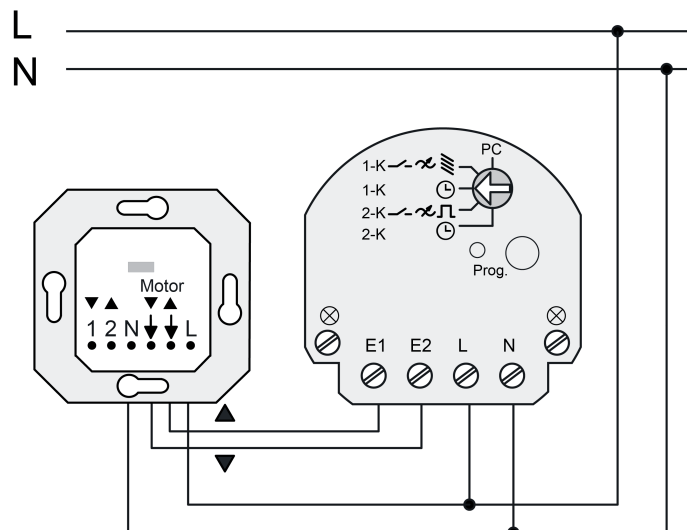

Figure 8: Connection example with venetian blind insert or other blind timers

Operating modes

The most common operating modes are set using the operating mode switch (1).

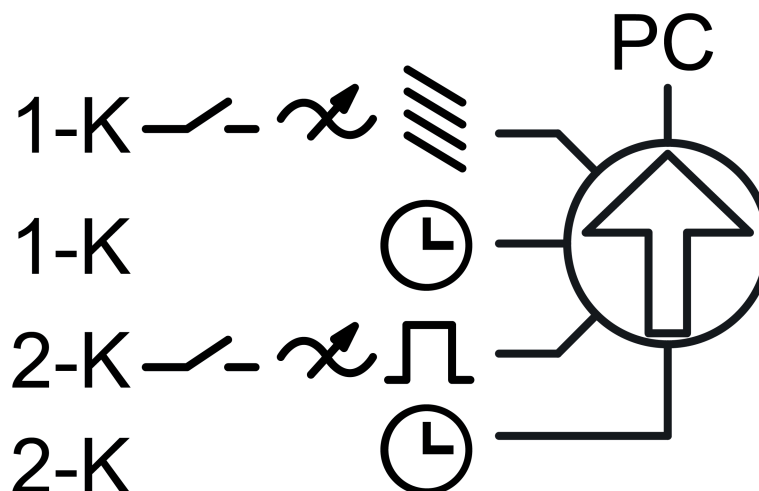

Figure 9: Operating mode switch

1-K : 1-gang switching/dimming/venetian blind for switch actuators, dimmer actuators (series push-buttons); venetian blind actuator (venetian blind push-button)

1-K : 1-gang automatic function for switch actuators, dimmer actuators (series push-buttons); shutter actuators (shutter switch, shutter insert, shutter push-button, shutter clock)

2-K : 2-gang switching/dimming/push-button operation for switch actuators, dimmer actuators, shutter actuators (2 push-buttons, series push-buttons)

2-K : 2-gang automatic functions for switch actuators, dimmer actuators (switches, motion detectors, timers)

In PC position, parameters can be set and additional operating modes are available:

- 2-gang blind for venetian blind actuator (series push-buttons, dead man's function)
- 2-gang scene
- Scenes for signal contact

- i** When the operating mode switch is in the **PC** position, the operating mode is set by the eNet server. Adjusting the operating mode switch overwrites the operating mode and the set parameters.

Operating modes for switching actuators and dimmer actuators

Separate control surfaces for switching on/off or dimming brighter/darker:

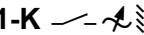
Control through	Series push-button (figure 2)
Function	2-area operation
Operating mode switch	1-K 
Operating mode with eNet server	1-gang switching/dimming/venetian blind
Function E1	Short: Switch on Long: Increase brightness
Function E2	Short: Switch off Long: Reduce brightness

Two push-button functions. Actuation switches alternately on/off or dims alternately brighter/darker:

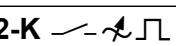
Control through	2 push-buttons (figure 5)
Function	2x 1-area operation
Operating mode switch	2-K 
Operating mode with eNet server	2-gang switching/dimming/push-button operation
Function E1, E2	Short: Alternate on/off Long: Alternate brighter/darker

Switching function for devices with switching contact:

Control through	2 switches, motion detectors, timers etc. (figure 4)
Function	2x 1-area operation
Operating mode switch	2-K 
Operating mode with eNet server	2-gang automatic functions
Function E1, E2	Close contact: On Open contact: Off

Operating mode for push-button actuators

Push-button actuator switches for the length of actuation:

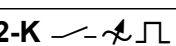
Control through	2 push-buttons (figure 5)
Function	2x 1-area operation
Operating mode switch	2-K 
Operating mode with eNet server	2-gang switching/dimming/push-button operation
Function E1, E2	Press: On Release: Off Max. actuation period 60 seconds

Operating modes for blind actuators

Blinds move for the length of actuation. Blind control units with switching function, venetian blind push-button with dead man's function:

Control through	Blind insert with e.g. timer cover (figure 8), venetian blind switch (figure 7) or venetian blind push-button (dead man's function)
Function	2-area operation
Operating mode switch	1-K ☹
Operating mode with eNet server	1-gang automatic function
Function E1	Press: Move up Release: Stop
Function E2	Press: Move down Release: Stop

Control venetian blind actuators with venetian blind push-button. Long actuation with self-retain:

Control through	Venetian blind push-button (figure 6)
Function	2-area operation
Operating mode switch	1-K 
Operating mode with eNet server	1-gang switching/dimming/venetian blind
Function E1	Short: Slats up or stop Long: Move upwards, continuous operation
Function E2	Short: Slats down or stop Long: Move downwards, continuous operation

Two push-button functions. Actuation moves alternately upwards/downwards; dead man's function:

Control through	2 push-buttons
Function	2x 1-area operation
Operating mode switch	PC
Operating mode with eNet server	2-gang blind
Function E1, E2	Press: Alternately move upwards/downwards Release: Stop

Two push-button functions. Actuation moves alternately upwards/downwards; long actuation with self-retain:

Control through	2 push-buttons
Function	2x 1-area operation
Operating mode switch	2-K 
Operating mode with eNet server	2-gang switching/dimming/push-button operation
Function E1, E2	Short: Alternately slats up/down or stop Long: Alternately move upwards/downwards, continuous operation

Operating mode for scenes

Control through	2 push-buttons
Function	2x 1-area operation
Operating mode switch	PC
Operating mode with eNet server	Scenes
Function E1, E2	Short: Open scene Long: Save scene Delivery state: E1: All off E2: Scene 1

Operating mode for signal contact

Control through	Switch, wind sensor, rain sensor, twilight sensor, timer, motion detector, etc.
Function	1× 1-area operation (only E1)
Operating mode switch	PC
Operating mode with eNet server	Scenes for signal contact
Function E1 (E2 without function)	Close contact: Send scene 1 Open contact: Send scene 2 Assignment to scenes and values only with eNet server.

5.2 Commissioning



DANGER!

Electrical shock when live parts are touched.

Electrical shocks can be fatal.

During commissioning, cover the parts carrying voltage on radio transmitters and actuators and in their surrounding area.

Presetting the operating mode

In the **PC** position, the operating mode is set with the eNet server and PC.

- Set the operating mode switch (1) to the desired position.
- Position **PC**: Set the operating mode and parameter with the eNet server.

Connecting radio transmitters and actuators

The radio transmitters and actuators are installed and switched on.

The operating modes for radio transmitters and actuators are set.

The input terminals **E1** and **E2** are deenergised.

- Switch the receiver to programming mode.
- Press **Prog.** button (2) for approx. 4 seconds.
The Status LED (3) flashes.
- 2-area operation, operating mode **1-K...**: actuate one of the input terminals **E1** or **E2**.

- or -

- 1-area operation, operating mode **2-K...**: actuate the input terminals of the appropriate function - **E1** or **E2**.
The transmitter and actuator save the connection.
The status LED (3) lights up.

The transmitter and actuator return to normal operation.

- i** Up to 10 actuators can be connected to a radio transmitter in a single step.
- i** If the status LED of the radio transmitter flashes 3 times at 1-second intervals for approx. 5 seconds, then the programming operation was not successful. The actuator is outside radio range, not in programming mode or there are radio faults.
- i** If the status LED of the actuator flashes 3 times at 1-second intervals for approx. 5 seconds, then the programming operation was not successful. All the memory locations in the actuator or radio transmitter are occupied.

Disconnecting the connection to actuators

- Carry out the same steps as when connecting (see Connecting radio transmitters to actuators).

The status LED (3) flashes quickly for 5 seconds. The actuator is disconnected from the radio transmitter. The actuator and radio transmitter exit the programming mode automatically.

- i** Multiple existing connections to outputs of a radio actuator must be disconnected individually.
- i** When the status LED (3) flashes 3 times at 1-second intervals, the operation was not successful and should be repeated.

Resetting the radio transmitter to the factory setting

All connections to actuators are disconnected and parameters are reset to default setting.

- i** The connections in the actuators are preserved and must be deleted separately.
 - Press the **Prog.** button for longer than 20 seconds.
The LED flashes after 4 seconds and rapidly after 20 seconds.
 - Release **Prog.** button and press briefly once again within 10 seconds.
The status LED flashes more slowly during the next 5 seconds. The device is reset to default setting.

Resetting an individual transmitter input

For this input, all the connections to actuators are disconnected and parameters are reset to default setting. The operating mode and general parameters remain intact.

- i** The connections in the actuators are preserved and must be deleted separately.
 - Press the **Prog.** button for longer than 20 seconds.
The LED flashes after 4 seconds and rapidly after 20 seconds.
 - Release the **Prog.** button and, within 10 seconds, briefly actuate the desired input terminal – **E1** or **E2**.
The status LED flashes more slowly during the next 5 seconds. The input is reset to default setting.

6 Appendix

6.1 Technical data

Rated voltage	AC 110 ... 230 V ~
Mains frequency	50 / 60 Hz
Standby power	0.5 W
Ambient temperature	-25 ... +70 °C
Inputs	
Cable length	max. 100 m
Input current at nominal voltage	approx. 2 mA
Signal duration	min. 200 ms
Signal lamp output	
Rated voltage	AC 110 ... 230 V ~
Output current	40 mA
Connection	

eNet universal radio transmitter 2-gang mini





single stranded	0.75 ... 4 mm ²
Finely stranded with conductor sleeve	0.75 ... 2.5 mm ²
Dimensions Ø×H	53×23 mm
Radio	
Radio frequency	868.0 ... 868.6 MHz
Transmission capacity	max. 20 mW
Transmitting range in free field	typ. 100 m
Receiver category	2

6.2 Parameter list

The device parameters can be changed with the eNet server:

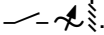
Device configuration

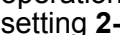
Parameter name	Setting options, Basic setting	Explanations
----------------	--------------------------------	--------------

<p>Function</p>	<p>Unused</p> <p>Scene</p> <p>1-gang switching/dimming/ Venetian blind</p> <p>1-gang automatic function</p> <p>2-gang switching/dimming/push- button operation</p> <p>2-gang automatic functions</p> <p>2-gang blind</p> <p>Scenes for signal contacts</p> <p>Unused</p> <p>Basic setting: 1-gang switching/dimming/venetian blind</p>	<p>Setting of the transmission behaviour suitable for operating concept and the connected operating elements.</p> <p>Unused The channel is not displayed in the eNet SMART HOME app and is disabled for use in the commissioning interface.</p> <p>Scene: 2 scene buttons. Control with push-button contacts.</p> <p>1-gang switching / dimming / Venetian blind: 1 channel, both inputs operate the same channel. Activation with 2 push-button contacts, e.g. series push-button (2-surface operation). Corresponds to the setting 1-K .</p> <p>1-gang automatic function: 1 channel, both inputs operate the same channel. Control with 2 switching contacts, e.g. with Venetian blind clock. Corresponds to the setting 1-K .</p> <p>2-gang switching/dimming/push-button operation: 2 channels, each input operates its own channel. Each control with push-button contact (1-surface operation). Corresponds to the setting 2-K .</p> <p>2-gang automatic function: 2 channels, each input operates its own channel. Activation with switching contact, e.g. switch, motion detector, timer. Corresponds to the setting 2-K .</p> <p>2-gang Venetian blind: 2 channels, each input operates its own channel. Control with push-button contacts (2-surface operation).</p> <p>Scenes for signal contacts: E1 and E2 each operate two scenes. When closing and opening, the respective scene is recalled. Control with switching contact</p>
-----------------	--	---

Operating mode	App use, lock-out protection, forced operation, wind alarm, sun protection, twilight Basic setting: App use	Setting the type of scene used for a scene button. Setting is always made in pairs.
----------------	--	---

Advanced device settings

Parameter name	Setting options, Basic setting	Explanations
Manual commissioning	On, Off Basic setting: On	Disables manual commissioning for all device channels. Note: In the "Off" setting, the device cannot be reset to the factory setting.
Repeater mode	On, Off Basic setting: Off	In addition to its other functions, the device can be used as a repeater. In the "On" setting, the device repeats all the received telegrams.
Switching edge E1	Rising, falling Basic setting: Rising	Specifies whether input 1 reacts to a rising or a falling edge. Rising: Control with NO contact push-button Falling: Control with NC contact push-button
Switching edge E2	Rising, falling Basic setting: Rising	Specifies whether input 2 reacts to a rising or a falling edge. Rising: Control with NO contact push-button Falling: Control with NC contact push-button

Extended channel settings

Parameter name	Setting options, Basic setting	Explanations
Manual commissioning	On, Off Basic setting: On	Blocks manual commissioning for the device channel. Note: In the "Off" setting, the device cannot be reset to the factory setting.
Local Operation	On, Off Basic setting: On	Blocks the input for local operation.

6.3 Troubleshooting

After a button has been pressed, the status LED flashes red quickly for 3 seconds.

Cause: Maximum permitted transmission period (statutory Duty Cycle Limit) has almost been reached. For the function of the transmitter to continue, the polling and display of the sum status will be switched off. As soon as sufficient transmission time is available again, the sum status will again be polled on button actuation.

Actuate the transmitter again after a short waiting time, normally a few seconds.

Reduce the number of actuations.

Reduce the number of actuators connected to the transmitter.

6.4 Accessories

Mounting adapter for mini housing

Art. No. FM-EBG

Push-button, NO contact, 1-pole, with separate signal contact, e.g. art. no. 534U

LED luminaire 230 V for switches and push-buttons, e.g. art. no. 90-LED..

6.5 Conformity

Albrecht Jung GmbH & Co. KG hereby declares that the radio system type

Art. No. FMUS2UP

corresponds to the directive 2014/53/EU. You can find the full article number on the device. The complete text of the EU Declaration of Conformity is available under the Internet address:

www.jung.de/ce

6.6 Warranty

The warranty follows about the specialty store in between the legal framework as provided for by law.

ALBRECHT JUNG GMBH & CO. KG

Volmestraße 1

58579 Schalksmühle

GERMANY

Telefon: +49 2355 806-0

Telefax: +49 2355 806-204

kundencenter@jung.de

www.jung.de