

eNet radiografische dimactor 1-voudig, voor DIN-rail

Art. no.: FMUD5500REG

Operating instructions**1 Safety instructions**

Electrical devices may only be mounted and connected by electrically skilled persons.

Serious injuries, fire or property damage possible. Please read and follow manual fully.

Danger of electric shock. Always disconnect before carrying out work on the device or load. In so doing, take all the circuit breakers into account, which support dangerous voltages to the device and or load.

Danger of electric shock. Device is not suitable for disconnection from supply voltage. The load is not electrically isolated from the mains even when the device is switched off.

Danger of electric shock. During installation and cable routing, comply with the regulations and standards which apply for SELV circuits.

Risk of destruction if the set operating mode and load type do not match. Set correct operating mode when connecting or exchanging the load.

Fire hazard. For operation with inductive transformers, each transformer must be fused on the primary side in accordance with the manufacturer's instructions. Only safety transformers according to EN 61558-2-6 may be used.

Fire hazard! Operation exclusively with the power supplies listed under accessories

These instructions are an integral part of the product, and must remain with the end customer.

2 Intended use

- Switching and dimming of lighting
- Operation with power supply RMD and receiver module RMD cover or eNet server (see accessories) Operation with power supply RMD and receiver module RMD cover or eNet server (see accessories)
- Operation with suitable radio transmitters
- Installation in small distributors on DIN rail according to EN 60715

Product characteristics

- Switch-on via bulb-preserving soft start
- Switch-on brightness can be saved permanently
- Minimum brightness can be saved permanently
- Scene operation possible
- Status indication with LED
- Status feedback to radio transmitter
- Switchable with **Prog.** button
- Electronic short-circuit protection with permanent switch-off after 7 seconds at the latest
- Electronic over-temperature protection
- Automatic or manual setting of the dimming principle suitable for the load
- It is possible to increase power by means of power packs

Can be set with eNet server:

- Maximum brightness
- Dimming speed
- Switch-on delay / switch-off delay
- Dim up/dim down ramp
- Switch-off warning

- Operation locks
- Continuous on, Continuous off
- Hotel function
- Run-on time
- Light control

Supplementary functions with eNet Server:

- Fully encrypted radio transmission (AES-CCM) from eNet Server software version 2.0
- Update of the device software
- Reading of error memory

Behaviour in case of bus voltage failure and return

If the bus voltage fails, the actuator switches off. The response to bus voltage return can be parameterised with eNet server. Default setting: Off.

3 Operation

- i** When operating with the eNet Server, operation and signalling could vary from what is described here.

Operation with radio transmitters

Operation is with radio transmitters, please observe the radio transmitter instructions.

Operation with Prog button

Switching the light

- Press button **Prog** (3) briefly.
The light switches on or off at the saved switch-on brightness.
Status-LED (4) lights up: output is switched on.
Status-LED (4) off: output is switched off.

Save switch-on brightness

- Set the light with a connected radio transmitter to the required brightness.
- Press the **Prog** button for longer than 4 seconds.
The light switches off briefly and then switches on again to the new switch-on brightness.
Switch-on brightness is saved.

- i** Alternatively, the switch-on brightness can be saved with a radio transmitter, e.g. wall transmitter.

4 Information for electrically skilled persons

4.1 Fitting and electrical connection



DANGER!

Mortal danger of electric shock.

Before carrying out work on the device or load, disengage all the corresponding circuit breakers. Cover up live parts!

Fitting the device

Observe the temperature range. Ensure adequate cooling. Maintain a distance of 18 mm (1 module) between the devices when operating multiple dimmers or power units within a sub-division.

- Mount device on DIN rail. Output terminals must be at the top.

Connect bus line

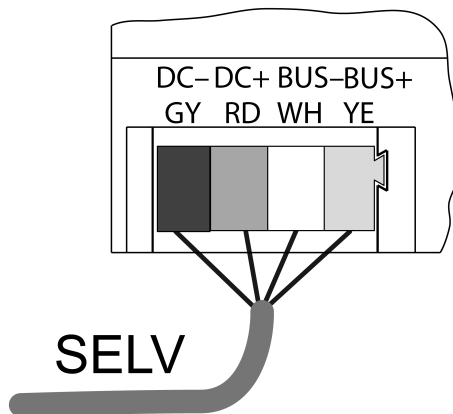

Figure 1: Connection diagram of bus line

| Labelling / Colour | Connection |
|--------------------|----------------|
| DC- / GY dark grey | Power supply - |
| DC+ / RD red | Power supply + |
| Bus- / WH white | Data cable - |
| Bus+ / YE yellow | Data cable + |

As bus line, use e.g. J-Y(St)Y 2x2x0.8

- Connect the device with bus line (Figure 1) to the RMD reception module and power supply (see instructions of RMD reception module and power supply).

Connect the load

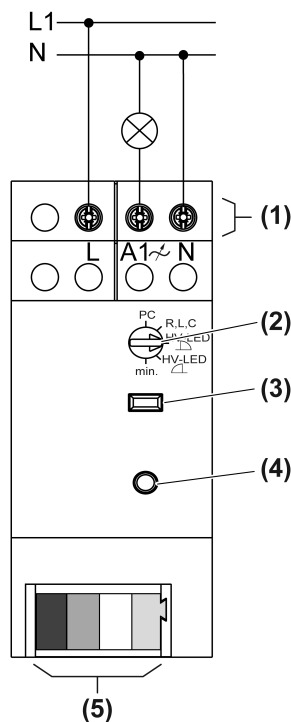

Figure 2: Connection diagram

- (1) Load connection

- (2) Operating mode switch
- (3) Button **Prog**
- (4) Status LED
- (5) Bus line connection

- i** Connect 600 Watt LED lamps or compact fluorescent lamps at most per 16 ampere circuit breaker. When connecting transformers, observe the data of the transformer manufacturer.
- i** Our dimmers take into account the different electronic characteristics of most LED lamps found on the market. However, it cannot be guaranteed that in individual cases the desired results may not be achieved.

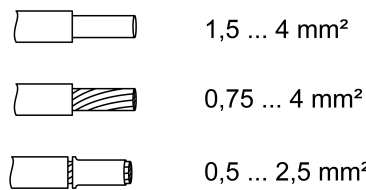

Figure 3: Clampable conductor cross-section

- Connect the load according to connection diagram (Figure 2)

Presetting the operating mode

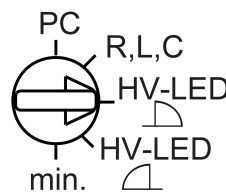

Figure 4: Operating mode switch

| Switch position | Function/connectable loads |
|--|--|
| PC | Dimming principle and parameter set with eNet Server.*) |
| R,L,C Universal | Automatic calibration to the load, leading edge phase control or trailing edge phase control. Connection of incandescent lamps, HV halogen lamps, electronic transformers for halogen or LED lamps or dimmable inductive transformers for halogen or LED lamps. |
| HV-LED \triangle LED leading edge phase control | Setting for incandescent lamps, HV halogen lamps, electronic transformers with halogen or LED lamps that can be dimmed according to the trailing edge phase control principle or dimmable HV-LED or compact fluorescent lamps that can be dimmed according to the leading edge phase control principle. The connection of inductive transformers is not permitted. |
| HV-LED \square LED trailing edge phase control | Setting for incandescent lamps, HV halogen lamps, electronic transformers with halogen or LED lamps that can be dimmed according to the trailing edge phase control principle, dimmable HV-LED or compact fluorescent lamps that can be dimmed according to the trailing edge phase control principle. The connection of inductive transformers is not permitted. |
| min. | Setting of the minimum brightness |

- *) If the operating mode switch is turned from the position **PC**, the operating mode and parameters are set to the default setting. The settings made with the eNet Server will be lost.
When setting the minimum brightness, the parameter settings remain unchanged.
- Set the operating mode switch.
 - Switch on mains voltage.

4.2 Commissioning



DANGER!

Electrical shock when live parts are touched.

Electrical shocks can be fatal.

During commissioning, cover the parts carrying voltage on radio transmitters and actuators and in their surrounding area.

- i** The actuator can also be commissioned with eNet Server as an alternative to the commissioning described here.

Connecting with radio transmitter

Load is switched off.

- Press the **Prog** button for longer than 4 seconds.
The status LED (4) flashes after 4 seconds. The actuator is in programming mode for approx. 1 minute.
- Switch radio transmitter to programming mode (see radio transmitter instructions).
- Trigger telegram on the radio transmitter.
The status LED lights up for 5 seconds.

The actuator is connected to the radio transmitter. The actuator and radio transmitter exit the programming mode automatically.

- i** If the status LED of the actuator flashes 3 times at 1-second intervals for approx. 5 seconds, then the programming procedure was not successful. All the memory locations in the actuator or radio transmitter are occupied.
- i** All On and All Off buttons of a radio transmitter are connected to the actuator automatically as soon as the first connection to a radio transmitter takes place. Scene buttons must be connected separately.

Disconnecting connection to a radio transmitter

- Carry out the same steps as when connecting (see Connecting to radio transmitter).
The status LED (4) flashes quickly for 5 seconds. The actuator is disconnected from the radio transmitter. The actuator and radio transmitter exit the programming mode automatically.
- i** If there several connections or scene buttons for a radio transmitter, all connections must be disconnected individually.
- i** All On and All Off buttons of a radio transmitter are disconnected automatically as soon as the last connection to the radio transmitter is disconnected. Manual disconnection is not possible.

Resetting actuator to default setting

All connections to radio transmitters are disconnected and parameters are reset to default setting. If the operating mode switch is on **PC**, the dimming principle universal, automatic calibration to the load, is set.

- i** The connections in the radio transmitters are preserved and must be deleted separately.

Load is switched off.

- Press the **Prog** button for at least 20 seconds.
The status LED flashes after 4 seconds. After 20 seconds the status LED flashes faster.
- Release **Prog** button and press briefly once again within 10 seconds.
The status LED flashes more slowly for approx. 5 seconds.
The actuator is reset to default setting.

Setting the minimum brightness

The minimum brightness can be set within a range of approx. 1...67 %, if, e.g. the light flickers at low brightness or to compensate for differences in brightness.

- Turn operating mode switch (1) to the **min.** position.
- Adjust brightness with the radio transmitter.
- Turn operating mode switch to the original position again.
When leaving the position **min.**, the minimum brightness is saved.

Save switch-on brightness

See operation.

5 Technical data

| | |
|---------------------|---------------|
| Rated voltage | AC 230 V~ |
| Mains frequency | 50 / 60 Hz |
| Power loss | max. 4 W |
| Standby power | max. 0.3 W |
| Ambient temperature | -5 ... +45 °C |

Connected load at 35°C (Figure 5)

- i** Power specifications including transformer power dissipation.
- i** Operate inductive transformers with at least 85% nominal load.
- i** For ohmic-inductive mixed load, maximum 50% proportion of ohmic load. Otherwise incorrect calibration of the dimmer may result.

| | | | |
|---|---|--|---|
|  |  |  |  |
| W 20...500 | W/VA 20...500 | W 3...100 | W/VA 20...100 |

Figure 5: Connected load

- i** If the operating mode is set to HV **LED**  LED trailing edge phase control, the maximum connected load for LED lamps increases to typ. 200 W.

Mixed load

| | |
|----------------------|------------------|
| ohmic-inductive | 20 ... 500 VA |
| ohmic-capacitive | 20 ... 500 VA |
| capacitive-inductive | not permitted |
| Ohmic and HV LED | typ. 3 ... 100 W |

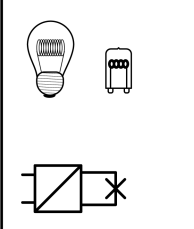
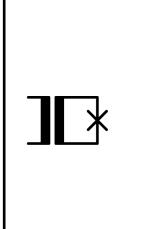
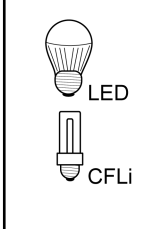
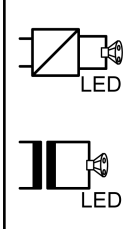
| | |
|--|--------------------------------|
| Ohmic and compact fl lamp. | typ. 3 ... 100 W |
| Power reduction per 5 °C in excess of 35 °C | -5% |
| Power boosters | See power booster instructions |
| Total length power cable per channel | 100 m |
| Fitting width | 36 mm / 2 module |
| RMD bus | |
| Rated voltage | DC 12 V SELV |
| Current consumption | 10 mA |
| Connection, Bus | device connection terminal |
| Cable length | max. 3 m |

6 Parameter list

The device parameters can be changed with the eNet server:

Device and channels

| Parameters | Setting options, Basic setting | Explanations |
|----------------|--|--|
| Function | Light, unused Basic setting: Light | Light The channel is integrated for the "Lighting" central function in the eNet SMART HOME app . Unused The channel is not displayed in the eNet SMART HOME app and is disabled for use in the commissioning interface. |
| Operating mode | Normal operation Continuous on Continuous off Basic setting: Normal Operation | Normal operation The output can be operated with radio transmitters and the Prog button. Continuous on The output switches to continuously "On". All operations of radio transmitters and the Prog button are ignored. Continuous off The output switches to con- |

| Parameters | Setting options, Basic setting | Explanations |
|------------|--------------------------------|---|
| | | tinuously "Off". All operations of radio transmitters and the Prog button are ignored. |

Advanced device settings

| Parameters | Setting options, Basic setting | Explanations |
|----------------------|--------------------------------|---|
| Manual commissioning | On, Off Basic setting: On | Blocks manual commissioning for the device channel. Note: In the "Off" setting, the device cannot be reset to the factory setting. |

Channel settings

| Parameters | Setting options, Basic setting | Explanations |
|-------------------------|------------------------------------|---|
| Switch-on brightness | 1...100 % Basic setting: 100 % | During brief operation, the output switches on at the set switch-on brightness. Note: If the value is above the set maximum brightness or below the minimum brightness, then the system will switch to the appropriate limit value. |
| Minimum brightness | 1...67 % Basic setting: 5 % | Specifies the minimum settable brightness. Note: If parameters or scene values are set to a level lower than the minimum brightness, then the system will dim to minimum brightness. |
| Maximum brightness | 75...100 % Basic setting: 100 % | Specifies the maximum settable brightness. Note: If parameters or scene values are set to a level higher than the maximum brightness, then the system will dim to maximum brightness. |
| Dimming adjustment time | 1...60 s Basic setting: 4 s | Time from minimum brightness until reaching maximum brightness (dimming speed). |
| Switch-on delay | 0 s ... 24 h Basic setting: 0 s | The load switches on after a delay. Repeated switch-on commands restart the delay time. If the load has not yet been switched on due to the delay when a switch-off command comes, then the load will remain off. Note: The set time apply to operation using radio transmitters. The device is switched immediately when the Prog button is pressed. |

| Parameters | Setting options, Basic setting | Explanations |
|--------------------------------------|------------------------------------|--|
| Switch-off delay | 0 s ... 24 h Basic setting: 0 s | The load switches off after a delay. Repeated switch-off commands restart the delay time. If the load has not yet been switched off due to the delay when a switch-on command comes, then the load will remain on. Note: The set time apply to operation using radio transmitters. The device is switched immediately when the Prog button is pressed. |
| Dim up ramp | 0 s ... 24 h Basic setting: 0 s | Time between switch-on and reaching switch-on brightness. The light is switched on at minimum brightness and then dimmed to the switch-on brightness. Only applies to switch-on with transmitters (short operation). If scenes are recalled or switching uses logic modules, the switch-on brightness is approached using so-called soft dimming (not configurable). |
| Dim down ramp | 0 s ... 24 h Basic setting: 0 s | Time until reaching minimum brightness. The light is dimmed to minimum brightness and then switched off. Only applies to switch-off with transmitters (short operation). If scenes are recalled or switching uses logic modules, the system switches off directly. |
| Run-on time | 0 s ... 24 h Basic setting: 0 s | As soon as a run-on time has been entered, the actuator will no longer remain on permanently, but only for the length of the run-on time. The run-on time is restarted if actuation is repeated. This parameter is directly connected to the "Manual switch-off of run-on time" parameter. Note: The set time apply to operation using radio transmitters. The device is switched immediately when the Prog button is pressed. |
| Manual switch-off of the run-on time | On, Off Basic setting: Off | Allows manual switch-off of a running run-on time. If the parameter is switched off, then a switch-off command |

| Parameters | Setting options, Basic setting | Explanations |
|-----------------|---|--|
| | | will also switch the actuator on. Only visible if a run-on time was set. |
| Operating hours | 0...65535 Basic setting: Current value | The time is counted during which the load is physically switched on. This parameter can be reset to "0", for example after exchanging the load. The Reset button is used to reset the counter to "0". The device must be programmed to apply the change. |

Extended channel settings

| Parameters | Setting options, Basic setting | Explanations |
|----------------------|---|--|
| Operating mode | Normal operation Continuous on Continuous off Basic setting: Normal Operation | see Device and channels |
| Manual commissioning | On, Off Basic setting: On | Blocks manual commissioning for the device channel. Note: In the "Off" setting, the device cannot be reset to the factory setting. |
| Local Operation | On, Off Basic setting: On | Blocks the output for operation using the Prog button. |
| Dimming principle | Universal LED leading edge phase control LED trailing edge phase control Leading edge phase control Trailing edge phase control Basic setting: Universal | Specifies the dimming principle for the selected output. Universal Automatic calibration to the load, dimming principle, leading edge phase control or trailing edge phase control. Connection of incandescent lamps, HV halogen lamps, Tronic transformers for halogen or LED lamps or dimmable inductive transformers for halogen or LED lamps. LED leading edge phase control Setting for phase-dimmable HV-LED or compact fluorescent lamps that can be dimmed according to the leading edge phase control principle. LED trailing edge phase control |

| Parameters | Setting options, Basic setting | Explanations |
|---|---|---|
| | | <p>Setting for phase-dimmable HV-LED or compact fluorescent lamps that can be dimmed according to the trailing edge phase control principle.</p> <p>Leading edge phase control Leading edge phase control dimming principle. Connection of incandescent lamps, HV halogen lamps, dimmable inductive transformers for halogen or LED lamps.</p> <p>Trailing edge phase control Dimming principle, trailing edge phase control. Connection of incandescent lamps, HV halogen lamps, Tronic transformers for halogen or LED lamps.</p> |
| Behaviour on voltage return | <p>On Off Last value Configured brightness Basic setting: Off</p> | Defines the behaviour of the output after voltage return. |
| Brightness on voltage return | <p>0...100 % Basic setting: 100 %</p> | <p>Brightness value, set by the output after voltage return (mains voltage). The parameter "Behaviour after voltage return" must be set to "Configured position".</p> <p>Note: If the value is above the set maximum brightness or below the minimum brightness, then the system will switch to the appropriate limit value.</p> |
| Behaviour after the end of the disabling function | <p>On Off no change Last value Basic setting: No change</p> | Behaviour of the output when a block is removed. |
| Manual saving of the scene values | <p>On, Off Basic setting: On</p> | Disables the saving of the current brightness value as scene value in an actuator for a command via a transmitter. |
| Switch-off warning | <p>On, Off Basic setting: Off</p> | If the switch-off warning is active, then, during switch-off, the system dims to minimum brightness within 30 seconds and only then switches off. If |

| Parameters | Setting options, Basic setting | Explanations |
|---|-----------------------------------|--|
| | | the parameter "Dim down ramp" is configured as longer than 30 s, then the length of the dim down ramp is applied. If, during the dim down operation, another command is given, e.g. switch on or scene recall, then the switch-off warning stops and the command is executed. A switch-off command restarts the time for the switch-off warning. Note: The set time apply to operation using radio transmitters. The device is switched immediately when the Prog button is pressed. |
| Priority, lock-out protection | 0...4 Basic setting: 1 | Specifies the priority for recalling and removing a scene of type Lock-out protection for the channel. Note: 1 is the highest priority and 4 the lowest. 0 means no priority. |
| Activate lock-out protection brightness value | 0...100 % Basic setting: 0 % | Defines the behaviour of the output on activating the lock-out protection. |
| Deactivate lock-out protection brightness value | 0...100 % Basic setting: 0 % | Defines the behaviour of the output on deactivating the lock-out protection. Only visible when the priority for the lock-out protection is 0. |
| Priority, restraint | 0...4 Basic setting: 2 | Specifies the priority for recalling and removing a scene of type Restraint for the channel. |
| Activate forced operation brightness value | 0...100 % Basic setting: 100 % | Defines the behaviour of the output on activating the forced operation. |
| Deactivate forced operation brightness value | 0...100 % Basic setting: 0 % | Defines the behaviour of the output on deactivating the forced operation. Only visible when the priority for the forced operation is 0. |
| Priority, wind alarm | 0...4 Basic setting: 3 | Specifies the priority for recalling and removing a scene of type Wind alarm for the channel. |
| Activate wind alarm brightness value | 0...100 % Basic setting: 0 % | Defines the behaviour of the output on activating the wind alarm. |

| Parameters | Setting options, Basic setting | Explanations |
|--|-----------------------------------|--|
| Deactivate wind alarm brightness value | 0...100 % Basic setting: 0 % | Defines the behaviour of the output on deactivating the wind alarm. Only visible when the priority for the wind alarm is 0. |
| Priority, sun protection | 0...4 Basic setting: 0 | Specifies the priority for recalling and removing a scene of type Sun protection for the channel. |
| Activate sun protection brightness value | 0...100 % Basic setting: 100 % | Defines the behaviour of the output on activating the sun protection. |
| Deactivate sun protection brightness value | 0...100 % Basic setting: 0 % | Defines the behaviour of the output on deactivating the sun protection. Only visible when the priority for the sun protection is 0. |
| Priority, twilight | 0...4 Basic setting: 0 | Specifies the priority for recalling and removing a scene of type Twilight for the channel. |
| Activate twilight brightness value | 0...100 % Basic setting: 100 % | Defines the behaviour of the output on activating the twilight function. |
| Deactivate twilight brightness value | 0...100 % Basic setting: 0 % | Defines the behaviour of the output on deactivating the twilight function. Only visible when the priority for the twilight function is 0. |
| Switch off brightness overshoot | On, Off Basic setting: On | Allows automatic switch-off according to the brightness. If the parameter is On, then the light controller switches off automatically when the brightness setpoint is greatly exceeded. Note: This parameter is not yet active, as a light controller has not yet been implemented. |
| Switch on brightness undershoot | On, Off Basic setting: Off | Allows automatic switch-on according to the brightness. If the parameter is On, then the light controller switches on automatically when the brightness setpoint is greatly undershot. We recommend only using the parameter in connection with the parameter "Switch-off on brightness overshoot". Note: This parameter is not |

| Parameters | Setting options, Basic setting | Explanations |
|----------------|--------------------------------|--|
| | | yet active, as a light controller has not yet been implemented. |
| Hotel function | On, Off Basic setting: Off | If the hotel function is activated, the system will dim to 20 % brightness when a switch-off command is made. Switch-off is only possible with a forced position command. Note: If the minimum brightness is set to greater than 20 %, then the system dims to the set minimum brightness when the hotel function is activated. |

Information window

In the Information window, the load can be controlled and the information about the device can be displays.

Channel control/channel information

| Display value | Explanations |
|---------------------------|---|
| Current dimming value | The load can be dimmed using the slider or a brightness value entry. |
| Load state | The load can be switched on or off. |
| Restraint | Display of forced position status. |
| Operating hours | Display of the operating hours since the last restart in the Settings window Einstellungen . |
| Display dimming principle | Display of the used dimming principle. |

7 Troubleshooting

Connected LED lamps or compact fluorescent lamps switch off in the lowest dimming position or flicker

The set minimum brightness is too low.
Increase minimum brightness.

Connected LED lamps or compact fluorescent lamps flicker

Cause 1: Lamps are not dimmable.
Check manufacturer's instructions.
Exchange lamps for another type.

Cause 2: Dimming principle and lamps do not optimally match.
Check operation in another dimming principle, reduce connected load as well if necessary.

Connected LED lamps or compact fluorescent lamps in the lowest dimming position are too bright; dimming range is too small

Cause 1: The set minimum brightness is too high.
Reduce minimum brightness.

Cause 2: HV-LED trailing edge phase control dimming principle does not optimally match the connected HV-LED lamps.

Check operation in the "HV-LED leading edge phase control" setting, reduce connected load as well if necessary.

Exchange lamps for another type.

The dimmer switches the load off briefly and then on again.

Cause: short-circuit protection has tripped but now there is no longer a fault.

Dimmer has switched off, status LED (4) flashes 3 times at intervals of 1 second

Cause 1: Operating mode switch (2) was set to another dimming principle.

The dimming principle was accidentally adjusted: Reset the original dimming principle on the operating mode switch (see section 5.1. Mounting and Electrical Connection).

The dimming principle was intentionally adjusted: Check whether the dimming principle matches the connected load. Switch mains voltage off and on again, the dimmer assumes the new setting.

Cause 2: overheating protection has tripped.

Disconnect dimmer from mains, also switch associated off circuit breakers.

HV-LED phase cut-off: Reduce the connected load. Exchange lamps for another type.

HV-LED phase cut-on: Reduce the connected load. Check operation in the "HV-LED trailing edge phase control" setting. Exchange lamps for another type.

Let dimmer cool down for at least 15 minutes. Check installation situation, ensure cooling, e.g. provide distance from surrounding devices.

Switch circuit breakers and dimmer on again.

Cause 3: Surge protection has triggered.

HV-LED trailing edge phase control: Check operation in the "HV-LED leading edge phase control" setting, reduce connected load as well if necessary.

Exchange lamps for another type.

Cause 4: short-circuit protection has tripped.

Switch off the mains supply.

Eliminate short-circuit.

Switch circuit breakers and dimmer on again.

i Short-circuit protection is not based on a conventional fuse, no metallic separation of the operational current.

Cause 5: load failure.

Check load, replace lamp. For inductive transformers, check primary fuse and replace if necessary.

Cause 6: mains voltage on the dimmer has failed.

Check mains voltage. After the return of the mains voltage, the dimmer executes the command that was last received.

Lamps flicker or buzz, proper dimming not possible, device buzzes

Incorrect operating mode set.

Cause: Incorrect operating mode set.

Check connected lamps. Correct the set operating mode.

LED lamp is dimly lit when dimmer is switched off

Cause: LED lamp is not optimally suited for this dimmer.

Use a compensation module, see accessories.

Use another type of LED lamp or an LED lamp of another manufacturer.

Dimmer has switched off, status LED is off.

RMD bus has failed.

Check RMD bus, power supply RMD and receiver module RMD.

8 Accessories

Power supply 12 V, for rail mounting
eNet master receiver for rail mounting
eNet server for rail mounting
Amplifier LED
Compensation module LED

Art. no. NT1220REGVDC
Art. no. FMFK32REG
Art. no. ENET-SERVER
Art. no. ULZ1755REG
Art. no. KMLED230U

9 Warranty

The warranty is provided in accordance with statutory requirements via the specialist trade.

ALBRECHT JUNG GMBH & CO. KG

Volmestraße 1
58579 Schalksmühle
GERMANY

Telefon: +49 2355 806-0
Telefax: +49 2355 806-204
kundencenter@jung.de
www.jung.de